

Müşteri Customer**Müşteri Ref. No.** Customer Ref. No.**Sipariş No.** Order No.

Ürün Product	3 Fazlı, tam kapalı, fan soğutmalı, sincap kafesli asenkron motor 3 Phase, totally enclosed, fan-cooled, squirrel cage induction motor		
Ürün Kodu Product Code	3M0SA4E-08MA21A0		
Motor Tipi Motor Type	3MAS 80MA2		
Kurulum Düzeni Mounting	IM B3		
Klemens Kutusu Konumu Terminal Box Pos.	Üstte on Top		
Verim Sınıfı Efficiency Class	IE4 verim sınıfı IE4 efficiency class		
Anma Gücü Rated Output P_N	0,75	kW	
Kutup Sayısı Pole Number	2		
Frekans Rated Frequency f_N	50	Hz	
Anma Gerilimi Rated Voltage U_N	230 / 400	V (D / Y)	
Devir Rated Speed n_N	2870	rpm	
Anma Akımı Rated Current I_N	2,82 / 1,63	A (D / Y)	
Anma Momenti Rated Torque T_N	2,50	Nm	
Eylemsizlik Momenti Inertia Moment J	0,0010	kg.m ²	
Yük Durumu Load Characteristics	4/4 100% load	3/4 75% load	2/4 50% load
Verim Efficiency η	83,5 %	83,6 %	82,2 %
Güç Faktörü Power Factor $\cos\phi$	0,80	0,71	0,55
Kalkış Akımı Locked Rotor Current I_A/I_N	6,8		
Kalkış Momenti Locked Rotor Torque T_A/T_N	3,3		
Devrilme Momenti Breakdown Torque T_K/T_N	3,8		
Koruma Derecesi Protection Degree	IP 55		
Yalıtım Sınıfı Insulation Class	F (155°C)		
Sıcaklık Artış Sınıfı Temp. Rise Class	B (80K)		
Ortam Sıcaklığı Ambient Temp.	-20°C +40°C		
Rakım Altitude	1000	m.a.s.l.	
Soğutma Yöntemi Cooling Method	IC 411		
Gürültü Düzeyi Sound Pressure Level	61	dB	
Titreşim Sınıfı Vibration Class	Derece A Grade A		
Çalışma Tipi Duty Type	S1		
Servis Faktörü Service Factor	1,15		
Motor Dönüş Yönü Direction of Rotation	Saat yönü veya saat yönünün tersi CW or CCW		
Yaklaşık Rotor Ağırlığı Appx. Rotor Weight	2,3	kg	
Yaklaşık Motor Ağırlığı Appx. Motor Weight	10,0	kg	
Rulmanlar Bearings	ÖN DE		ARKA NDE
	6204 ZZ/CM		6204 ZZ/CM
Yeniden Yağlama Periyodu Relubrication Period	-		
Yağ Miktarı Grease Amount	-		
Yağ Cinsi Grease Type	-		

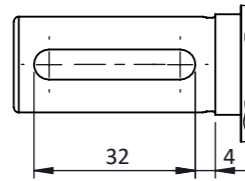

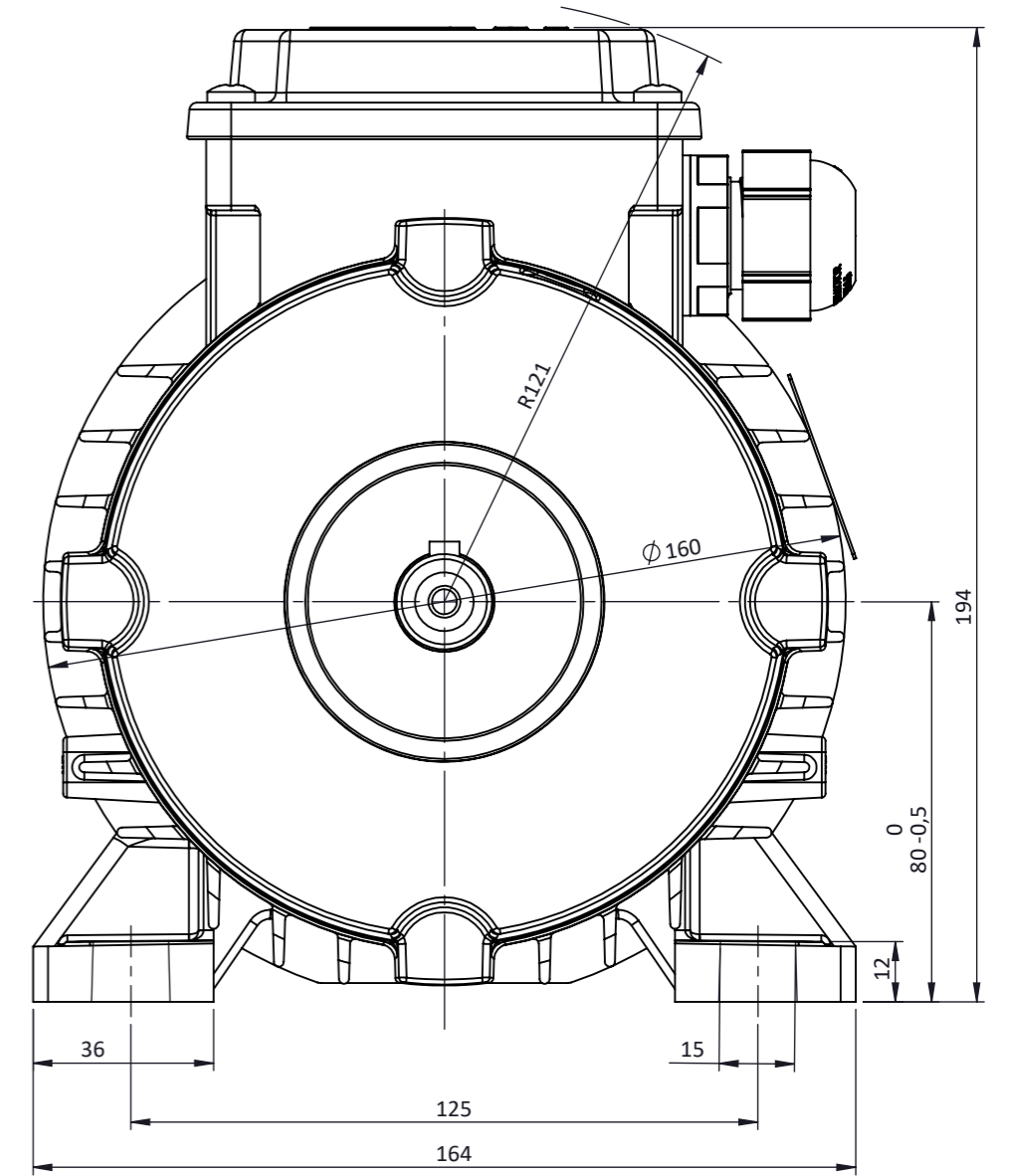
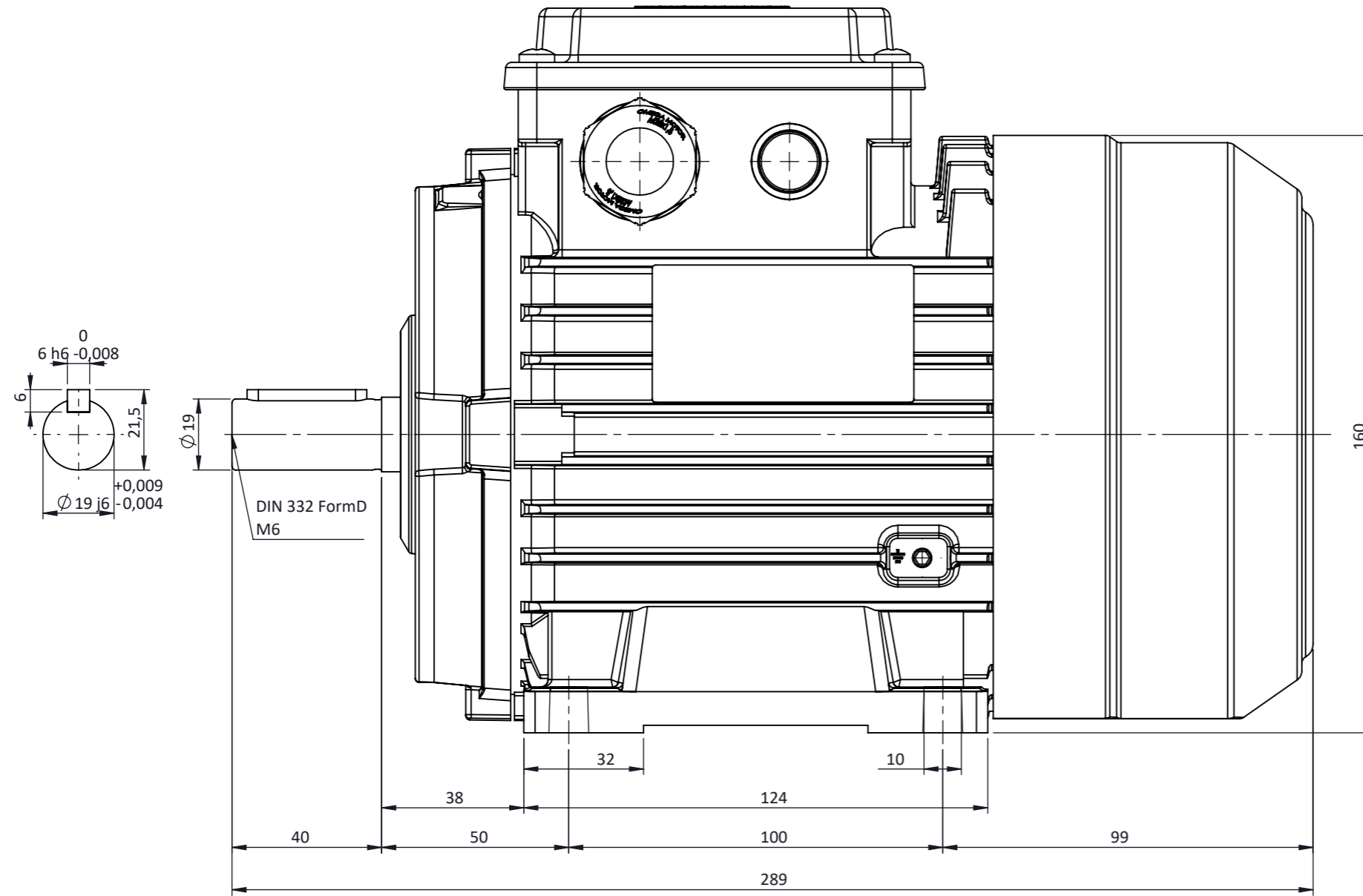

NOT:

	TARİH / DATE	İSİM / NAME	İMZA / SIGN.	MALZEME / MATERIAL				
ÇİZEN / DRAWN	27.11.2017	Nur YAYDEMİR		-----				
KONT. / CHECK		Mustafa ATAK						
ONAY / APPR.		Şerif ÖZTÜRK						
	PARÇA ADI / PART NAME			ADET QUANTITY	SERTLİK HARDNESS	KÜTLE MASS Kg	ÖLÇEK SCALE 1:1.5 A3	RESİM NO DRAWING NO A-80M-B3-T
OMEGA Motor Sanayi A.Ş.'nin izni olmadan üçüncü şahıslara verilemez. OMEGA imzalı ve mühürlü olmayan resimler geçersizdir. Bütün hakları saklı ve gizlidir.								SERİ NO: Ω80B3-T